

**TView QuadScan
USER'S MANUAL
Revision 2.00**

Focus Enhancements
600 Research Drive
Wilmington MA 01887
Phone: 978-988-5888
Tech Support: 978-988-5505
Fax: 978-988-7555

1	INTRODUCTION	5
1.1	INTENT OF THIS MANUAL	5
1.2	THE QUADSCAN FAMILY	6
1.3	OPERATIONAL SPECIFICATIONS.....	8
1.4	PRODUCT ORDERING OPTIONS.....	10
2	INSTALLATION	11
2.1	QUAD SCAN DESKTOP VERSION INSTALLATION	12
2.2	QUAD SCAN RACKMOUNT VERSION INSTALLATION	14
3	QUADSCAN CONTROL FUNCTIONS	16
3.1	COMPONENT LEVEL	16
3.2	OUTPUT SCREEN ASPECT RATIO	17
3.3	RESET AND CONTROL FUNCTIONS.....	17
3.4	MOTION PROCESSING.....	18
3.5	SIGNAL ROUTING.....	18
3.6	OUTPUT SYNC SIGNAL CONFIGURATION	19
3.7	DISPLAY DEVICE CONFIGURATION	19
3.8	TERMINATION.....	20
3.9	INPUT SOURCE SELECTION	20
3.10	INPUT TELEVISION VIDEO FUNCTIONS.....	21
3.11	OUTPUT WINDOW CONTROL	22
3.12	INPUT TELEVISION WINDOW CONTROL	22
3.13	INPUT ASPECT RATIO SELECTION	23
4	QUADSCAN CONTROL METHODS	24
4.1	FRONT PANEL CONTROL	24
4.2	IR REMOTE CONTROL.....	26
4.3	RS-232/422 CONTROL.....	28
5	APPENDIX A - LIMITED WARRANTY	34

1 Introduction

The Focus Enhancements TView QuadScan product family is a series of products intended to receive analog television signals in various formats, scale them upwards in resolution and play them back on high-resolution projection devices. Using the QuadScan, users can vastly improve the visual quality of television sources.

The QuadScan is a Video Scaler, which means that the output resolution can be controlled or “scaled” to fit the resolution of the output device. “Line Doubling” and “Line Quadrupling” are just 2 of the many scaling modes of the QuadScan’s operation.

In addition to scaling incoming video to the optimum resolution of the display device, the QuadScan provides 2 other functions in significantly improving the displayed quality of television: 1) the video is de-interlaced for presentation on a non-interlaced device, removing the effects of interlaced flicker and 2) the video is “motion compensated”, automatically detecting the input source (i. e. still video, motion video, or film) and processing the video for minimal motion artifacts.

The QuadScan III is intended for use in two major type of users: Professional AV Users, and Home Theater Users. Professional AV users will be able to control all of the QuadScan’s control functions from popular control environments via RS-232/422. Home Theater Users will be able to access powerful video enhancement features previously found only in devices costing \$10,000 and up.

1.1 *Intent of this Manual*

This manual is intended to specifically cover the requirements of users of desktop and rackmount QuadScans. At the time of writing, a PCI bus version is planned. This product will require a different manual.

All references made by this manual to "QuadScan" (without suffix of any kind) refer generically to any member of the QuadScan product family.

This manual serves two purposes: 1) Quick Start Procedure, and 2) Reference Guide. If you are familiar with video systems or you just want a quick start, you may want to skip ahead to the appropriate installation section, plug the QuadScan and give it a try.

1.2 The QuadScan Family

The QuadScan product family consists of one common technology implemented on a common circuit board. Different packaging is added to the base product to provide specific options.

1.2.1 Desktop or Rackmount

Desktop Units are standalone items that accept 13 – 20 VDC power from a UL listed power supply. Users of Desktop QuadScans may choose between American compatible, wall mount transformers, with standard American plug configuration (shipped automatically with QuadScan Desktop orders, SKU# 444-5520), or deskmount universal power supplies (shipped with QuadScan Desktop International orders, SKU#444-5524). Desktop universal power supplies terminate in an IEC-320 connector (the same connector that you see on the back of PC computers). You must supply the IEC-320 to wall outlet cable.

QuadScan is also available in an EIA 19 inch rack mount configuration. The QuadScan Rackmount (SKU #444-5522) occupies 1 standard rack height. The unit is shipped with rackmount brackets (ears) in the package, but not installed. All QuadScan rackmount models are capable of accepting power in the range of 95 V - 250 V, 47Hz. - 63 Hz. You must supply the IEC-320 to wall outlet cable for countries requiring other than the American 3 prong plug..

1.2.2 Standard Packout for QuadScan Desktop (SKU #444-5520)

The following is a list of components that are shipped as a part of the standard QuadScan Desktop packout:

- 1 QuadScan desktop unit
- 1 American Wall Transformer
- 1 BNC Male – BNC Male Cable
- 1 S-VHS Male to S-VHS Male Cable (4 pin Mini-DIN)
- 1 HD-15 Male to HD-15 Female Cable
- 4 RCA Female to Male BNC Connector Adapters
- 1 QuadScan IR Remote Control
- 1 QuadScan Manual

In addition to the above components, the user may order other cables, components and spare parts for special applications. A list of these items and their part numbers appears in section 1.4.

1.2.3 Standard Packout for QuadScan Desktop (SKU #444-5524)

The following is a list of components that are shipped as a part of the standard QuadScan Desktop International packout:

- 1 QuadScan desktop unit
- 1 IEC-320 International power supply
- 1 BNC Male – BNC Male Cable
- 1 S-VHS Male to S-VHS Male Cable (4 pin Mini-DIN)
- 1 HD-15 Male to HD-15 Female Cable
- 4 RCA Female to Male BNC Connector Adapters
- 1 QuadScan IR Remote Control
- 1 QuadScan Manual

In addition to the above components, the user may order other cables, components and spare parts for special applications. A list of these items and their part numbers appears in section 1.4.

1.2.4 Standard Packout for QuadScan Rackmount (SKU #444-5522)

The following is a list of components that are shipped as a part of the standard QuadScan Rackmount packout:

- 1 QuadScan rackmount unit
- 1 Left rackmount bracket
- 1 Right rackmount bracket
- 6 bracket mounting screws
- 1 BNC Male – BNC Male Cable
- 1 S-VHS Male to S-VHS Male Cable (4 pin Mini-DIN)
- 4 RCA Female to Male BNC Connector Adapters
- 1 QuadScan IR Remote Control
- 1 QuadScan Manual

In addition to the above components, the user may order other cables, components and spare parts for special applications. A list of these items and their part numbers appears in section 1.4.

1.2.5 RS-232/422 Control

All QuadScan Desktop and Rackmount items are controllable over RS-232 or RS-422. The choice of communication standard is chosen by selecting hardware jumpers. The default is RS-232. The ability to control the QuadScan over RS-232/422, requires the purchase of RS-232/422 control cable (SKU 444-5007). This item can be ordered at the time of QuadScan purchase or any time later.

1.3 Operational Specifications

1.3.1 Input Signal Formats

2 channels of base band NTSC or PAL (automatically recognized) composite **BNC Female (1)**
2 channels of NTSC or PAL (automatically recognized) S-VHS (Y/C) **4 pin Mini-DIN Female**
2 channels of Component (Y,R-Y,B-Y or YPbPr) (European or NTSC timing) **BNC Female (3)**
1 channel of HD-15 VGA pass through **HD-15 Male**

THE QUADSCAN DOES NOT SUPPORT NON-INTERLACED INPUT.

1.3.2 Output Signal Formats

Hi Resolution RGB (RGBH and V shall appear on pins 1,2,3,13, and 14) **HD-15 Female**
Component YPbPr (HDTV Style; Pr, Y, Pb appear on pins 1,2,3) **HD-15 Female**
(YPbPr available by special order only)

1.3.3 Output Resolutions

Resolution	Color Space	Aspect Ratio	Mode Title **
720 x 480 (NTSC)	RGB	4:3	DBL TV
720 x 576 (PAL)	RGB	4:3	DBL TV
640 x 480	RGB	4:3	VGA
800 x 600	RGB	4:3	SVGA
1024 x 768	RGB	4:3	XGA
720 x 720 (NTSC)	RGB	16:9	TRIPLE TV
720 x 864 (PAL)	RGB	16:9	TRIPLE TV
720 x 960 (NTSC)	RGB	16:9	QUAD TV
720 x 1152 (PAL)	RGB	16:9	QUAD TV
1280 x 720	RGB	16:9	HDTV
1365 x 1024	RGB	4:3	D-ILA

VGA pass through is an analog pass through of the VGA input connected to the QuadScan's VGA IN connector. When VGA pass through is selected, the VGA input (Red Green Blue, H Sync and V Sync) is passed directly through to the HI-RES OUT connector. No resolution scaling or signal processing is performed.

THE QUADSCAN DOES NOT SUPPORT INTERLACED OUTPUT.

1.3.4 Motion Compensation Modes

Motion Video (from 2 field interlaced video image acquisition)
Film (3:2 Pull Down) (from 24 fps film image acquisition)
Static Video
Automatically detect and process Motion Video, 3:2 Pulldown or Static Video

1.3.5 Signal Routing Capability

The A Channel of all three types of television inputs (composite, Y/C and Component) may be independently re-routed to the B-channel enabling pass through of the A signal to the B connector.

1.3.6 Control Methods

Front Panel Keyboard

IR Remote (Supplied)

RS-232/422 (cable ordered as an Accessory)

DB-9 Male

1.3.7 Power Consumption

Desktop Unit:

13-20 VDC 20W

Unit is shipped with a 13 Volt DC power supply, center positive, 2.5 mm barrel connector (male side on the unit). At 13 V., the desktop unit consumes a maximum of 1.5 A.

Rackmount Unit:

120 V. 0.25 A.

240 V. 0.15 A.

1.3.8 Physical Size

Desktop Unit:

7.5" X 7.25" X 2.0"

Rackmount Unit:

19.0" X 10.0" x 1.75" (rack mount brackets installed)

17.0" X 10.0" x 1.75" (rack mount brackets not installed)

1.3.9 Environmental

Desktop Unit:

Operating Temperature: 0 to 40 degrees Celsius

Storage Temperature: -40 to 125 degrees Celsius

Humidity: 0 to 90%, non-condensing

Rackmount Unit:

Operating Temperature: 0 to 40 degrees Celsius

Storage Temperature: -40 to 125 degrees Celsius

Humidity: 0 to 90%, non-condensing

1.4 Product Ordering Options

1.4.1 Ordering Guide

QuadScan Products are named as follows:

Name	SKU	Description
TView QuadScan	444-5520	Desktop, American
TView QuadScan-International	444-5524	Desktop, International
TView QuadScan-RM	444-5522	Rackmount*

* Please note that the QuadScan Rackmount is shipped with an American Power Cord, but may be used anywhere in the world.

1.4.2 Available Accessories for the QuadScan

The following list details the available accessory items cables that connect the QuadScan to various types of AV equipment

Part Number	SKU	Description	Included
0080-6003-100	444-5006	QuadScan IR Remote	Yes
0027-2000-100	444-5007	RS-232/422 Control Cable	No
0087-2000-100	444-5009	HD15 Female to HD15 Male	Yes
0087-2001-100	444-5008	HD15 Male to HD15 Male	No
8-5600-000009	444-5010	American Wallmount Power Supply	With Desktop
8-5600-000011	444-5011	Universal Deskmount Power Supply	With Desktop, International
8-6000-000003	444-5012	American Power Cord	With Rack Mount
8-2100-000089	444-5013	RCA Female to BNC Male Adapter	Yes (4)
0105-2000-100	444-5014	Cable, HD15 F to F, Genderchanger	No
0103-2000-100	444-5906	Cable, HD15 Male to 5 BNC Male	No
0107-2000-100	444-5914	Cable, 5 BNC Male to 5 BNC Male	No
0110-2000-100	444-5015	Cable, 1 BNC Male to 1 BNC Male	Yes
0001-7000-100	444-5016	Cable, S-VHS to S-VHS	Yes

2 Installation

Installation of all QuadScan products is a simple and quick procedure, but is slightly different for each of the following versions.

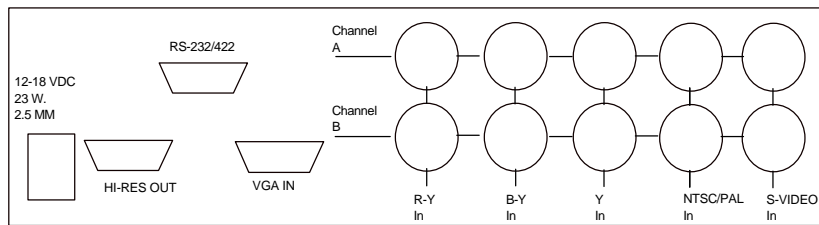

Figure 1: QuadScan Desktop Back Plate Diagram

2.1 Quad Scan Desktop Version Installation

Follow these steps to install your Desktop QuadScan.

Turn all system components off.

Select a convenient location for the QuadScan.

Plug the QuadScan's wallmount power supply into an appropriate outlet or power strip. Plug the 2.5mm connector of the wallmount power supply into the QuadScan.

Determine the signal connections on the display device.

If the display device has BNC inputs, you will require an HD15 Male to 5 BNC Male Cable (SKU# 444-5906). Connect the HD-15 side of this cable into the Hi-Res Output of the QuadScan. Connect the 5 wires of the BNC Male connectors (Red, Green, Blue, H Sync and V Sync) to the appropriate BNC Female connectors of the display device.

If the display device has a cable that terminates in an HD-15 Male connector, this device may be directly connected to the Hi-Res Out connector of the QuadScan.

If the display device has a cable that terminates in an HD-15 Female connector, you will require an HD15 Male to HD15 Male Cable (SKU# 444-5008). Connect one end of the HD-15 Male Connector to the Hi-Res Output connector of the QuadScan. Connect the other end of the HD15 Male to HD15 Male Cable to the HD-15 Female input of the display device.

Determine the required signal connections for the television device(s). In all cases, it is best to connect to the QuadScan's Channel A connector if a second channel is not required.

Composite sources will have either RCA or BNC connections.

If the source has a BNC connector, you can connect directly to the Channel A or B NTSC/PAL IN connector with the supplied BNC Male to BNC Male Cable.

If the source has an RCA connector, attach one of the supplied RCA Female to BNC Male adapters to the channel A or B NTSC/PAL IN connectors. Connect the Television device to the adapter with an RCA Male to RCA Male cable (not supplied).

S-VHS Sources are easily connected by connecting the S-VHS output of the television device to the channel A or B S-VHS IN connector of the QuadScan.

Component sources will have either RCA or BNC connections.

If the source has BNC connectors, you will require a 5 BNC Male to 5 BNC Male Cable (SKU # 444-5914), (actually only 3 wires of the 5 wire cable will be required). Connect the Y channel of the component source to the QuadScan's Channel A or B Y IN connector. Connect the R-Y (or Pr) channel of the component source to

the QuadScan's Channel A or B R-Y IN connector. Connect the B-Y (or Pr) channel of the component source to the QuadScan's Channel A or B B-Y IN connector.

If the source has RCA connectors, attach three of the supplied RCA Female to BNC Male adapters to the channel A or B Y IN, R-Y IN, and B-Y IN connectors. Connect the Television device to the adapter with an RCA Male to RCA Male cable(s) (not supplied). Connect the Y channel of the component source to the QuadScan's Channel A or B Y IN connector. Connect the R-Y (or Pr) channel of the component source to the QuadScan's Channel A or B R-Y IN connector. Connect the B-Y (or Pr) channel of the component source to the QuadScan's Channel A or B B-Y IN connector.

Determine if VGA pass through is desired you will require an HD15 Female to HD15 Male Cable (SKU# 444-5008).

Connect the VGA device's HD-15 output to the QuadScan's VGA IN connector with this cable.

Turn the all of the system components on. Makes sure that the correct input channel of the display device is selected on the display device. Turn the television source(s) on. Tune the VGA source material on.

If the system has been correctly installed, you will see one of the sources appearing on the display device. The QuadScan's signal priority scheme is as follows. As configured from the factory, the default resolution is 640 x 480, and the default signal priority scheme is automatic. (The automatic signal priority scheme will automatically detect all active signals present on the QuadScan's input connectors and automatically select the highest priority signal for processing. The signal priority is 1) VGA pass through, 2) Channel A Component, 3) Channel B Component, 4) Channel A S-Video, 5) Channel B S-Video, 6) Channel A Composite, 7) Channel B Composite.) The QuadScan saves user information including resolution and selected input source. If this is other than a first time installation, the above resolution and signal priority scheme may not be in effect.

2.2 Quad Scan Rackmount Version Installation

Follow these steps to install your rackmount QuadScan.

Turn all system components off.

Select a convenient location for the QuadScan.

If the QuadScan is to be mounted within a 19 inch rack, install the left and right mounting brackets with the supplied screws.

Plug the QuadScan into an appropriate outlet or power strip.

Determine the signal connections on the display device.

If the display device has BNC inputs, you will require an HD15 Male to 5 BNC Male Cable (SKU# 444-5906). Connect the HD-15 side of this cable into the Hi-Res Output of the QuadScan. Connect the 5 wires of the BNC Male connectors (Red, Green, Blue, H Sync and V Sync) to the appropriate BNC Female connectors of the display device.

If the display device has a cable that terminates in an HD-15 Male connector, this device may be directly connected to the Hi-Res Out connector of the QuadScan.

If the display device has a cable that terminates in an HD-15 Female connector, you will require an HD15 Male to HD15 Male Cable (SKU# 444-5008). Connect one end of the HD-15 Male Connector to the Hi-Res Output connector of the QuadScan. Connect the other end of the HD15 Male to HD15 Male Cable to the HD-15 Female input of the display device.

Determine the required signal connections for the television device(s). In all cases, it is best to connect to the QuadScan's Channel A connector if a second channel is not required.

Composite sources will have either RCA or BNC connections.

If the source has a BNC connector, you can connect directly to the Channel A or B NTSC/PAL IN connector with the supplied BNC Male to BNC Male Cable.

If the source has an RCA connector, attach one of the supplied RCA Female to BNC Male adapters to the channel A or B NTSC/PAL IN connectors. Connect the Television device to the adapter with an RCA Male to RCA Male cable (not supplied).

S-VHS Sources are easily connected by connecting the S-VHS output of the television device to the channel A or B S-VIDEO IN connector of the QuadScan.

Component sources will have either RCA or BNC connections.

If the source has BNC connectors, you will require a 5 BNC Male to 5 BNC Male Cable (SKU # 444-5914), (actually only 3 wires of the 5 wire cable will be required). Connect the Y channel of the component source to the QuadScan's Channel A or B Y IN connector. Connect the R-Y (or Pr) channel of the component source to

the QuadScan's Channel A or B R-Y IN connector. Connect the B-Y (or Pr) channel of the component source to the QuadScan's Channel A or B B-Y IN connector.

If the source has RCA connectors, attach three of the supplied RCA Female to BNC Male adapters to the channel A or B Y IN, R-Y IN, and B-Y IN connectors. Connect the Television device to the adapter with an RCA Male to RCA Male cable(s) (not supplied). Connect the Y channel of the component source to the QuadScan's Channel A or B Y IN connector. Connect the R-Y (or Pr) channel of the component source to the QuadScan's Channel A or B R-Y IN connector. Connect the B-Y (or Pr) channel of the component source to the QuadScan's Channel A or B B-Y IN connector.

Determine if VGA pass through is desired you will require an HD15 Female to HD15 Male Cable (SKU# 444-5008).

Connect the VGA device's HD-15 output to the QuadScan's VGA IN connector with this cable.

Turn the all of the system components on. Makes sure that the correct input channel of the display device is selected on the display device. Turn the television source(s) on. Tune the VGA source material on.

If the system has been correctly installed, you will see one of the sources appearing on the display device. The QuadScan's signal priority scheme is as follows. As configured from the factory, the default resolution is 640 x 480, and the default signal priority scheme is automatic. (The automatic signal priority scheme will automatically detect all active signals present on the QuadScan's input connectors and automatically select the highest priority signal for processing. The signal priority is 1) VGA pass through, 2) Channel A Component, 3) Channel B Component, 4) Channel A S-Video, 5) Channel B S-Video, 6) Channel A Composite, 7) Channel B Composite.) The QuadScan saves user information including resolution and selected input source. If this is other than a first time installation, the above resolution and signal priority scheme may not be in effect.

3 QuadScan Control Functions

All of the powerful features of the QuadScan that can be controlled through by its three methods of control described in section 4: front panel control, RS-232/422 and IR remote control. All methods are interchangeable and simultaneously active (i. e. a front panel button push can be followed by an IR remote control command).

Not all controllable items are accessible by the IR remote mouse. This provision is deliberately intended to prevent the user of an IR remote mouse from accidentally changing the resolution to an unsupported resolution, (an causing the display to “disappear”), etc.

QuadScan control functions are grouped into one of the following areas:

- Component Level (BetaCam, SMPTE)
- Output Screen Aspect Ratio (4:3, 16:9)
- Reset and Control Functions (Mode Reset, Full Reset, IR Enable/Disable)
- Motion Processing (Still, Film, Motion Video)
- Signal Routing (Channel A to B pass through)
- Output Sync Signal Configuration (3,4,5 wire)
- Output Display Device Configuration (Resolution and implied Aspect Ratio)
- Source Termination (75 Ohm or Unterminated)
- Input Source Selection (Composite, S-Video, Component, VGA)
- Input Television Video Functions (Hue, Saturation, Brightness and Contrast)
- Output Window Control (Size and Position)
- Input Television Window Control (Input Size and Position)
- Input Aspect Ratio Selection (16:9 anamorphic, 4:3 full screen, 4:3 letterbox)

Each of the controls has one of three possible types of control parameters associated with it:

- Toggle (the function is either on or off),
- Multiple Choice (there are several, mutually exclusive options)
- Range (the parameter varies over a range of values for a particular function).

3.1 *Component Level*

3.1.1 **Component Level Selection (Toggle) (Not available from IR remote mouse)**

This control selects the component signal level to BETA (Betacam Levels) or SMPTE (SMPTE Levels). The default is BETA.

3.2 Output Screen Aspect Ratio

3.2.1 Output Screen Aspect Ratio (Multiple) (Not Available from IR remote mouse)

The Output Screen Aspect Ratio control interacts with the Output Display Device Configuration and Input Aspect Ratio Selection to position the scaled and process image in the best screen position for a given combination. It is important to remember that the Screen aspect ratio is different from the Display Device aspect ratio. (for example, using a D-ILA projection system with a display device resolution of 1365 x 1024, aspect ratio of 4:3, a user may optimize his projection room for 16:9 viewing by focusing the projector on a 16:9 screen. This will effectively reduce the resolution of the projection system to 1365 x 768. The pixels outside the 1365 x 768 viewing area are still active (although black) and may be focussed into the floor or the ceiling to achieve the desired maximum viewing area at 16:9. Since the exact position of the 1365 x 768 “active video” window within the 1365 x 1024 raster of the D-ILA is not known, 3 position settings are provided:

- A) positions the 1365 x 768 active video strip at the top of the 1365 x 1024 raster.
- B) positions the 1365 x 768 active video strip in the middle of the 1365 x 1024 raster.
- C) positions the 1365 x 768 active video strip at the bottom of the 1365 x 1024 raster.

When 16:9 Output Aspect Ratio is selected, the QuadScan will determine the best presentation of the image upon a 16:9 screen based also on the Display Device Resolution and the Input Aspect Ratio selected. Similar action will be performed for 4:3 aspect ratio screens if 4:3 Output Aspect Ratio is chosen. The choices of Output Screen Size are:

Output Aspect Ratio	Front Panel Designation
16:9 Top	16:9A
16:9 Middle	16:9B
16:9 Bottom	16:9C
4:3 Top	4:3A
4:3 Middle	4:3B
4:3 Bottom	4:3C

The Output Aspect Ratio Control default is 4:3B. The Output Aspect Ratio Control is restricted to 4:3B for all input modes of 800 x 600 and less.

3.3 Reset and Control Functions

3.3.1 IR ON/OFF (Toggle) (Not available from IR remote mouse)

This control enables/disables IR Remote Control.

3.3.2 Mode Reset

This control resets the current mode to its factory default. Each “mode” is defined as being a Input Source-Output Resolution combination. (For example, PAL composite input on Channel B scaled to XGA output is one mode). The Mode Reset control affects only the current mode, all others will remain as previously configured by the user.

3.3.3 Full Reset (Not available from IR remote mouse)

This control resets all of the modes of the QuadScan to their factory default values.

3.4 Motion Processing

3.4.1 Motion Processing (Multiple)

This control determines which type of video motion processing will be applied. The options are:

Motion Processing Mode	Front Panel Designation
Auto	Auto
Film	Film
Motion	Motion
Still	Still

Film Processing (3:2 pulldown sourced material) is used to compensate for the motion artifacts of video program material from film sources. Motion Processing is used to compensate for the motion artifacts of motion video program material from 60 Hz. (50 Hz. PAL) video sources. Still Processing is used to deliver the highest possible resolution for still video program material (such as the output of a document camera focussed at a page). Automatic Processing (Auto) analyzes the incoming video program material and selects the most appropriated motion treatment from these three options. The default Motion Processing is AUTO.

Motion Processing Selection is indicated by “DSP=” followed by the abovementioned designation on the QuadScan’s Front Panel Display.

3.5 Signal Routing

3.5.1 Component YUV Pass Through (Toggle) (Not available from IR remote mouse)

This control determines whether the Component television input on Channel A is routed through to Channel B or not. If the signal is “passed through” Component television that is input on Channel A will appear as an output on Channel B. If the signal is not passed through, Channel B Component television will be configured as a second Component television input. The default is Channel B configured as an input.

YUV Channel B Configuration is indicated by “YUV B = PASS” or “YUV B= INPUT” on the QuadScan’s Front Panel Display.

3.5.2 S-VHS Pass Through (Toggle) (Not available from IR remote mouse)

This control determines whether the S-VHS television input on Channel A is routed through to Channel B or not. If the signal is “passed through” S-VHS television that is input on Channel A will appear as an output on Channel B. If the signal is not passed through, Channel B S-VHS television will be configured as a second S-VHS television input. The default is Channel B configured as an input.

S-VHS Channel B Configuration is indicated by “SVHS B=PASS” or “SVHS B=INPUT” on the QuadScan’s Front Panel Display.

3.5.3 Composite Pass Through (Toggle) (Not available from IR remote mouse)

This control determines whether the Composite television input on Channel A is routed through to Channel B or not. If the signal is “passed through” Composite television that is input on Channel A will appear as an output on Channel B. If the signal is not passed through, Channel B Composite television will be configured as a second Composite television input. The default is Channel B configured as an input.

Composite Channel B Configuration is indicated by “COMP B=PASS” or “COMP B=IN” on the QuadScan’s Front Panel Display.

3.6 Output Sync Signal Configuration

3.6.1 Output Sync Signal Configuration (Multiple) (Not available from IR remote mouse)

This control determines where output video synchronization signals will be placed

Output Sync	Front Panel Designation
Separate H and V (pins 13 and 14)	Osync= 5WIRE
Separate Composite (pin 14)	Osync= 4WIRE
Composite Sync on Green (pin 2)	Osync= 3WIRE

The Default is Separate Composite Sync (H and V) on pin 2.

3.7 Display Device Configuration

3.7.1 Display Device Configuration (Multiple) (Not available from IR remote mouse)

The Display Device Configuration operates in conjunction with the Input Aspect Ratio and the Output Screen Aspect Ratio to provide the correct scaling for the particular output. Several resolutions are supported as follows:

Resolution	Aspect Ratio	Mode Title
720 x 480 (NTSC)	4:3	DBL TV
720 x 576 (PAL)	4:3	DBL TV
640 x 480	4:3	VGA
800 x 600	4:3	SVGA
1024 x 768	4:3	XGA
720 x 720 (NTSC)	16:9	TRIPLE TV
720 x 864 (PAL)	16:9	TRIPLE TV
720 x 960 (NTSC)	16:9	QUAD TV
720 x 1152 (PAL)	16:9	QUAD TV
1280 x 720	16:9	HDTV
1365 x 1024	4:3	D-ILA

The Default is DBL TV **

3.8 Termination

3.8.1 VGA Termination (Toggle) (Not available from IR remote mouse)

This control engages or disengages 75 Ohm termination resistors on the RGB lines of the VGA pass through. The default configuration is termination resistors engaged.

VGA Termination is indicated by “VGA TERM” (VGA input Terminated) or “VGA UNTERM” (VGA Unterminated) on the QuadScan’s Front Panel Display.

3.8.2 Channel A Termination (Toggle) (Not available from IR remote mouse)

This control engages or disengages 75 Ohm termination resistors simultaneously on the Component, S-Video and Composite input lines of channel A. The default configuration is termination resistors engaged.

Channel A Termination is indicated by “CH A TERM” (Channel A Input Terminated) or “CH A UNTERM” (Channel A Input Unterminated) on the QuadScan’s Front Panel Display.

3.8.3 Channel B Termination (Toggle) (Not available from IR remote mouse)

This control engages or disengages 75 Ohm termination resistors simultaneously on the Component, S-Video and Composite input lines of channel B. The default configuration is termination resistors engaged.

Channel B Termination is indicated by “CH B TERM” (Channel B input Terminated) or “CH B UNTERM” (Channel B Input Unterminated) on the QuadScan’s Front Panel Display.

3.9 Input Source Selection

3.9.1 Input Source Selection (Multiple)

This control selects which input television source will be processed and displayed. The options are:

Input Source	Front Panel Designation
Auto	AUTO
VGA Pass Through	PASS VGA
Channel A Component	YUV A
Channel B Component	YUV B
Channel A S-Video	SVHS A
Channel B S-Video	SVHS B
Channel A Composite	COMP A
Channel B Composite	COMP B

When the “Auto” option is selected, the QuadScan will automatically select, process and display the source with the highest priority. The priority scheme is listed above with VGA pass through as the highest priority and Channel B Composite as the lowest. The default source is “AUTO”.

Input Source Selection is indicated by “IN=” followed by the above mentioned channel designation on the QuadScan’s Front Panel Display.

3.10 Input Television Video Functions

3.10.1 Brightness (Range)

This control adjusts the Brightness of the selected television source. Brightness is not accessible from the front panel when the selected input source is VGA pass through or AUTO. The default value for Brightness will produce internal digital values in accordance with ITU656 when a 100% amplitude, 100% saturation color bar test pattern is applied to the QuadScan's composite input. The default value for Brightness will produce RGB analog output at the HI RES OUT connector with a full scale range of 0.0 to 0.7 V. when a 100% amplitude, 100% saturation color bar test pattern is applied to the QuadScan's composite input. The default value is indicated by the numerals "16". The range of Brightness is 0 – 255 units.

3.10.2 Contrast (Range)

This control adjusts the Contrast of the selected television source. Contrast is not accessible from the front panel when the selected input source is VGA pass through or AUTO. The default value for Contrast will produce internal digital values in accordance with ITU656 when a 100% amplitude, 100% saturation color bar test pattern is applied to the QuadScan's composite input. The default value for Contrast will produce RGB analog output at the HI RES OUT connector with a full scale range of 0.0 to 0.7 V. when a 100% amplitude, 100% saturation color bar test pattern is applied to the QuadScan's composite input. The default value is indicated by the numerals "128". The range of Contrast is 0 – 255 units.

3.10.3 Saturation (Range)

This control adjusts the Saturation of the selected television source. Saturation is not accessible from the front panel when the selected input source is VGA pass through or AUTO. The default value for Saturation will produce internal digital values in accordance with ITU656 when a 100% amplitude, 100% saturation color bar test pattern is applied to the QuadScan's composite input. The default value for Saturation will produce RGB analog output at the HI RES OUT connector with a full scale range of 0.0 to 0.7 V. when a 100% amplitude, 100% saturation color bar test pattern is applied to the QuadScan's composite input. The default value is indicated by the numerals "128". The range of Saturation is 0 – 255 units.

3.10.4 Hue (Range)

This control adjusts the Hue of the selected television source. Hue does not affect PAL composite or S-Video input. Hue is not accessible from the front panel when the selected input source is VGA pass through or AUTO. The default value for Hue will produce internal digital values in accordance with ITU656 when a 100% amplitude, 100% saturation color bar test pattern is applied to the QuadScan's composite input. The default value for Hue will produce RGB analog output at the HI RES OUT connector with a full scale range of 0.0 to 0.7 V. when a 100% amplitude, 100% saturation color bar test pattern is applied to the QuadScan's composite input. The default value is indicated by the numerals "0". The range of Hue is -128 to 127 units.

3.11 Output Window Control

3.11.1 Output Horizontal and Vertical Position (Range) (Not available from IR remote mouse)

This control enables the user to position the “Output Window” with respect to the raster scan of the display device. Most display devices have a wide range of capability in mapping the boundary of the raster scan to the boundary of the viewable area. This control is provided to enable additional control in the event that the user’s display device does not provide sufficient range. This control is always operational, however it should not be adjusted until after the display device’s size and position controls have proved inadequate. The default configuration for the size and position of the Output Window are the raster parameters that are specified by VESA’s monitor standards.

Output Horizontal and Vertical Position is indicated by OUT HV POS on the QuadScan’s Front Panel Display.

3.11.2 Output Horizontal and Vertical Size (Range) (Not available from IR remote mouse)

This control enables the user to control the size of the “Output Window” with respect to the raster scan of the display device. Most display devices have a wide range of capability in mapping the boundary of the raster scan to the boundary of the viewable area. This control is provided to enable additional control in the event that the user’s display device does not provide sufficient range. This control is always operational, however it should not be adjusted until after the display device’s size and position controls have proved inadequate. The default configuration for the size and position of the Output Window are the raster parameters that are specified by VESA’s monitor standards.

Output Horizontal Size is indicated by OUT HV SIZE on the QuadScan’s Front Panel Display.

3.12 Input Television Window Control

3.12.1 Input Horizontal and Vertical Position (Range)

This control enables the user to position the “Input Window” with respect to the input television source. The Input Window is a smaller section of the television input that will be used as the scaling source. The Input Horizontal and Vertical Position works in conjunction with the Input Horizontal and Vertical Size Control. The default Input Position is with the Input Window exactly aligned with the timing boundaries of active video as specified for NTSC and PAL.

Input Horizontal and Vertical Position is indicated by IN HV POS on the QuadScan’s Front Panel Display.

3.12.2 Input Horizontal and Vertical Size (Range)

This control enables the user to control the size of the “Input Window” with respect to the input television source. The Input Window is a smaller section of the television input that will be used as the scaling source. As the Input Size is adjusted, the QuadScan will zoom the contents of the Input Window to the full screen size as defined by the Output Display Configuration and Output Screen Aspect Ratio. The Input Horizontal and Vertical Position works in conjunction with the Input Horizontal and Vertical Size. The default Input Size is with the Input Window exactly aligned with the timing boundaries of active video as specified for NTSC and PAL.

Input Horizontal and Vertical Size is indicated by IN HV SIZE on the QuadScan’s Front Panel Display.

3.13 Input Aspect Ratio Selection

3.13.1 Input Aspect Ratio Selection (Multiple)

This Control enables the QuadScan to adapt to different aspect ratios of popularly available video program material. Recorded television material comes in 3 forms:

- A) 4:3 full screen aspect ratio
- B) 16:9 full screen aspect ratio (often called anamorphic)
- C) letterbox format (16:9 aspect ratio strip with in a 4:3 aspect ratio screen)

The Input Aspect Ratio Selection operates in conjunction with the Output Display Device Configuration and Output Screen Aspect Ratio to ensure that the QuadScan provides a picture of maximum area upon the output screen.

The Input Aspect Ratio Selection Options are

Input Source	Front Panel Designation
4:3 Full Screen	Input= 4:3
16:9 Full Screen (Anamorphic)	Input=16:9
Letter box	Input=4:3LB

The default is 4:3 Full Screen.

4 QuadScan Control Methods

QuadScan models can be controlled in one of 3 different ways: Front Panel, RS-232/422, or InfraRed Remote Control. The following sections detail the use of each of these control mechanisms. In all cases, the state of a particular function of the QuadScan is indicated on the QuadScan's Front Panel LED readout. On power-up, the LED display indicates "QUADSCAN".

4.1 Front Panel Control

The QuadScan Front Panel gives the user access to all of the control parameters detailed in section 3.1. Figure 2 indicates the placement of the buttons and LED display on the Front Panel of the QuadScan.

The controls are arranged such that the user can cycle through a circular list of controllable functions with the + or - buttons. Using the + button advances the controlled item to the next item in the list. Using the - button reverses the controlled item to the previous item in the list. Depending on the nature of the controlled item, the directional arrow buttons function differently.

If the controlled item is a Toggle (i. e. Channel Termination, Zoom, etc.) with a position of either On or Off, then the activation of any one of the arrow buttons will toggle the state of the controlled item.

If the controlled item is a Multiple Choice (i. e. Input Source, Output Resolution) with several mutually exclusive positions, then the activation of the Up Arrow or Down Arrow buttons will Increment or Decrement the state of the controlled item to the next state. When the last state is reached, the next state will be the first state.

If the controlled item is a Range (i. e. Input Horizontal and Vertical Size and Position, etc), then the arrow buttons increase or decrease the value of these quantities. The increase or decrease is proportional to the length of time that the button is pressed.

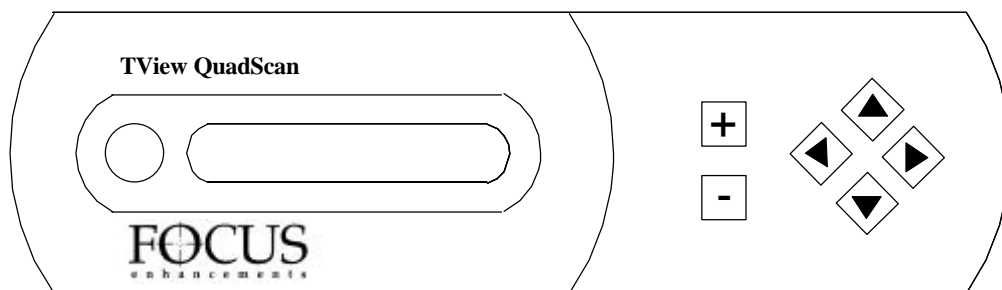

Figure 2: Position of Front Panel Controls

4.1.1 Locking the Front Panel

A special combination of buttons (the Locking Sequence) makes it possible to freeze control input such that the QuadScan will not respond to Control Panel or IR remote or RS-232/422 commands until a second special combination of buttons (the Unlocking Sequence) is entered. The locking sequence consists of: Advance the panel menu to "QuadScan", first press the "down" key and while still pressing the "down" key, press the "-" key. The LED readout will indicate "LOCKED" and all further input will be ignored until the Unlocking Sequence is entered. The Unlocking Sequence consists of: First press the "down" key and while still pressing the "down" key, press the "+" key. Locking will persist even after the QuadScan is power cycled. All input from the IR remote control will be ignored. The Locking and Unlocking Sequence may be delivered by the RS-232/422 link as indicated in section 4.3 below.

4.2 IR Remote Control

The hand held IR remote control enables the user to access many of the functions of the QuadScan. Since the IR unit is intended to access the most commonly used functions, certain setup functions of the QuadScan may only be accessed via the Front Panel or via RS-232/422. This prevents the accidental use of some controls (i. e. switching to an unsupported output resolution) and keeps the interface simple. The Remote Control interface is indicated in Figure 3. The Remote Control is a line of sight device; the IR receiver is mounted inside the QuadScan next to the LED displays. The Remote Control will only operate when it is within the line of sight of the LEDs of the QuadScan. The maximum range is about 25 feet.

Several controls are available from the IR unit, (Input Horizontal and Vertical Size and Position, Video Functions, selection of the Motion Processing Type, and selection of the Input Source)

The Input Horizontal Size and Position may be activated by pressing the Size/Position/Zoom button. The first touch of this button enables the Input Horizontal and Vertical Size to be adjusted with the positional button of the Remote Mouse. A second touch of this button enables the Horizontal and Vertical Position to be adjusted with the positional button of the Remote Mouse. Subsequent touches of this button continue cycling through these 2 functions in the indicated order.

The Video Functions of Contrast, Brightness, Saturation and Hue may be activated by touching the Video Function button. The first touch of this button enables the Brightness to be adjusted with the positional button of the Remote Mouse. The second touch of this button enables the Contrast to be adjusted with the positional button of the Remote Mouse. The third touch of this button enables the Saturation to be adjusted with the positional button of the Remote Mouse. The fourth touch of this button enables the Hue to be adjusted with the positional button of the Remote Mouse. Subsequent touches of this button continue cycling through these 4 functions in the indicated order.

The selection of the Motion Processing Type may be activated by touching the Motion Processing button. The first touch of this button selects Automatic Motion Detection and Compensation. The second touch of this button selects Film Processing Mode. The third touch of this button selects Video Motion Processing Mode. The fourth touch of this button selects Still Video Mode. Subsequent touches of this button continue cycling through these 4 functions in the indicated order.

The selection of the Input Source may be activated by touching the Signal Routing Button. The first touch of this button selects the automatic selection of input source according to the priority scheme of 3.3.10 (VGA, YUV A, YUV B, S-VHS A, S-VHS B, Composite A, Composite B). The second touch of this button selects VGA pass through (if present, or the next highest priority device if no VGA signal is present). Subsequent touches of this button cycle descend through the priority list, cycling through to the top.

The Selection of the Input Aspect Ratio may be achieved with the Trigger button of the IR Remote. The first touch of this button selects 4:3 Aspect Ratio Input. The second touch of this button selects Letterbox 4:3 input. The third touch of this button selects 16:9 Aspect Ratio Input. Subsequent touches of this button continue cycling through these 3 functions in the indicated order.

Operation of the IR remote control may be enabled or disabled by the use of Front Panel or RS-232/422 Control. If the IR appears to be ineffective, examine the IR ON/OFF selection using the Front Panel to ensure that the IR Remote is ON.

4.2.1 Mode Reset with the IR Remote Control

The IR Remote Control unit's Reset button will execute a QuadScan Mode Reset

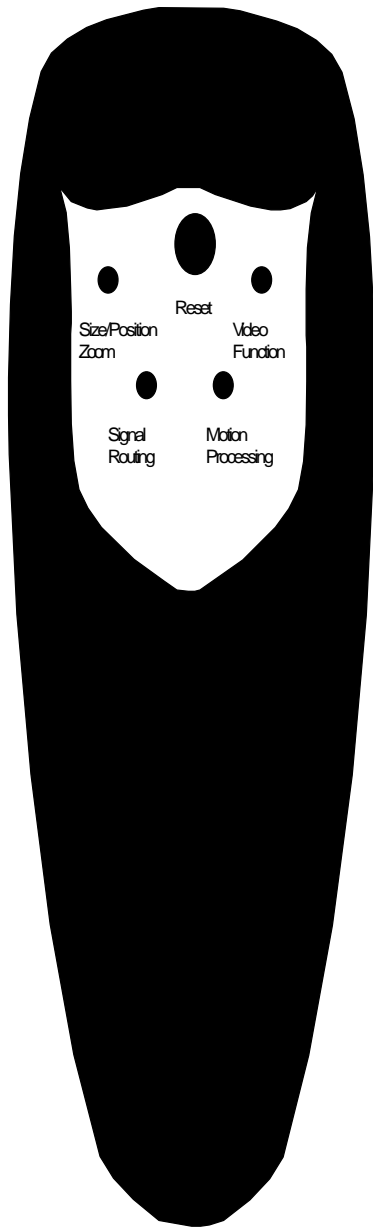

Figure 3: Remote Control Interface

4.3 RS-232/422 Control

All of the functions detailed in section 3.1 are available from RS-232/422 control. Every QuadScan is operable in both RS-232 and RS-422, but must be correctly set up for each standard. When configured for RS-422, up to 8 QuadScans may be connected in a single RS-422 wired system. The QuadScans will react to controls that are delivered to a unique address that is programmed into each QuadScan via the Front Panel control.

When configured for RS-232, only a single QuadScan may be attached to the RS-232 link. The default configuration is RS-232.

4.3.1 Configuring the QuadScan for RS-232 or RS-422

Jumper JP3 on the QuadScan's Control Interface board selects RS-232 or RS-422. Depending on the configuration of this jumper, the DB-9 communications connector located on the front panel of the QuadScan will accept either RS-232 or RS-422.

Figure 4 indicates the positioning of Jumper JP3. In the case of RS-422, the user has the additional choice of selecting a 120 Ohm termination.

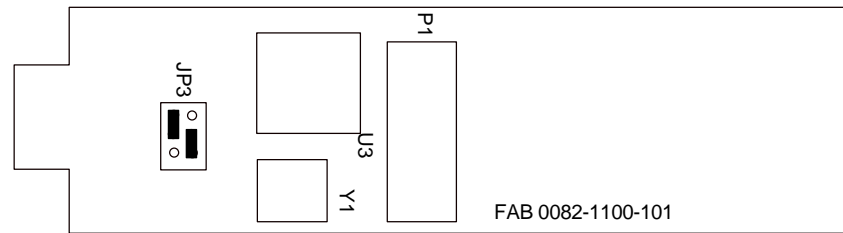

RS-232

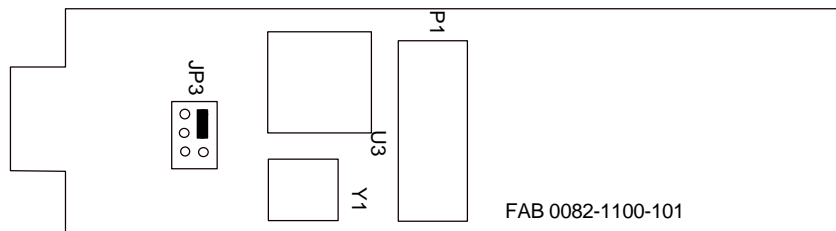

RS-422 (Unterminated)

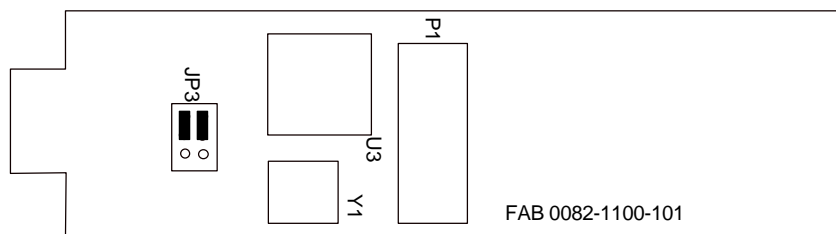

RS-422 (120 Ohm Termination)

Figure 4: Position of Jumper JP3 for RS232 or RS422 Control

4.3.2 Connecting the QuadScan to communications devices

Slightly different connections schemes are required for RS-232 and RS-422 operation.

Figure 5 indicates the recommended connections from a DB-9 connector for RS-232 operation. Depending on the way that the controlling port is programmed, other connections may work as well. The QuadScan has no way of handling the RTS/CTS and DSR/DCD signals.

Figure 6 indicates the recommended connections from a DB-9 connector for RS-422 operation. In this case, a simple 9 pin to 9 pin cable will work in all cases.

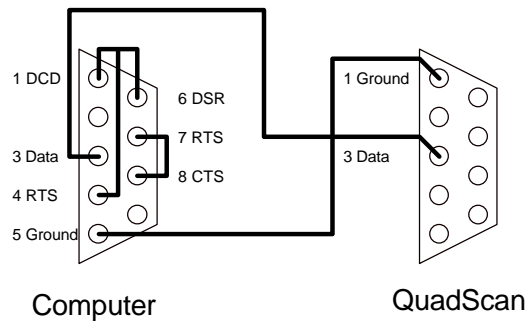

Figure 5: Recommended RS-232 Wiring

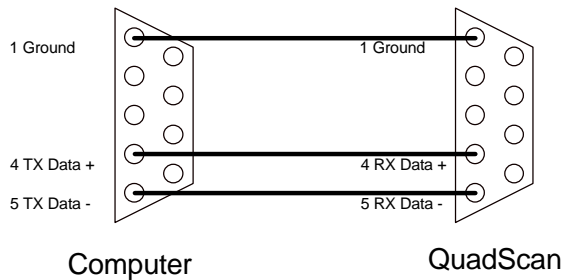

Figure 6: Recommended RS-422 Wiring

4.3.3 Selecting the QuadScan's address

In an RS-422, there may be as many as 8 QuadScans operating within a system. In order to provide a control mechanism to differentiate each QuadScan, the user must program each QuadScan's address using the Front Panel.

Programming the address is a simple procedure. Turn the QuadScan on, or cycle the control sequence such that the Power Up Identification is visible (i. e. "QUADSCAN") on the LED display. Press the Right Arrow Button. You will see the QuadScan's address indicated on the LED display. When you are finished, press either the + button or the - button. The QuadScan will remember its address until you change it in the same fashion.

The address circuitry is active even when you are using the RS-232 link (which does not permit multiple QuadScans or other devices to be connected in a multiple unit configuration). The default address is 0.

4.3.4 Sending Communications Commands to the QuadScan

The serial port of the QuadScan accepts serial data at 9600 baud, 8data bits, no parity bit, 1 stop bit. It is essential that the serial communications device that delivers commands to the QuadScan be set up in this fashion.

The QuadScan accepts 8 bit characters as commands. The commands to turn the QuadScan on and off are received as strings of ASCII alphabetic characters and binary numbers. For the purposes of this manual, all ASCII characters and binary numbers will be referred to with the decimal numbering sequence (i. e. the minimum value of a byte is 0, the maximum value of a byte is 255, the value of an upper case A is 65).

The Command sequence for communicating with the QuadScan is as follows:

1) The Activation Command is given. The Activation Command consists of the character string: QSRONx (where x is the address of the QuadScan). The Activation Command (and all other commands) must be followed by a Carriage Return (ASCII character value of 13 decimal) to be accepted.

The following byte string (using decimal values for ASCII characters) indicates a valid Activation Command for a QuadScan previously programmed to be address 3:

81	83	82	79	78	03	13
Q	S	R	O	N	3	<CR>

If the QuadScan receives any unexpected input before the reception of the Activation Command, it will ignore it. If it receives an unexpected byte during the transmission of the Activation Command, the Activation Command must be re-transmitted (the Activation sequence is reset).

2) Individual Commands are given. Any number of commands may be given after the QuadScan is activated. The QuadScan individual commands consist of 2 byte strings. Each 2 byte string is an internal Register Number Byte followed by a Value Byte. The Value Byte has a different meaning and legal range for each register. Each command (i. e. Register Number Byte, followed by Value Byte) must be concluded with a Carriage Return.

The Value Byte provides "absolute information" if the parameter in question is a Toggle or Multiple Choice Item. If the parameter in question is a range item, the Value Byte provides "relative information" incrementing or decrementing the existing value of that parameter by on count.

In addition to the above commands, two additional commands are provided for control information. Writing Value Byte = 01 to register 18 will cause a Full Reset operation to occur. Writing Value Byte = 01 to register 20 will cause the existing parameter set to be written in to NOVRAM. The QuadScan will subsequently power up with these saved parameters until the NOVRAM is once again changed by writing a 01 to register 18.

The following table indicates the Register Functions, the Register Number, Parameter Type and action of the legal values of the Value Byte.

Register Name	Reg #	Type	Value Byte Action (Hexadecimal Byte)
Input H and V Position	1	Range	=01 increment H, =02 decrement H, =03 increment V, =04 decrement V
Input H and V Size	2	Range	=01 increment H, =02 decrement H, =03 increment V, =04 decrement V
Output H and V Position.	3	Range	=01 increment H, =02 decrement H, =03 increment V, =04 decrement V
Brightness	4	Range	=00 to 255
Contrast	5	Range	=00 to 255
Hue	6	Range	=00 to 255
Input Source Select	7	Multiple	=01 Auto, =02 VGA Pass, =03 YUV A, =04 YUV B =05 S-VHS A, =06 S-VHS B, =07 Composite A, =08 Composite B
Channel A Termination	8	Toggle	=01 Terminate, =00 UnTerminate
Channel B Termination	9	Toggle	=01 Terminate, =00 UnTerminate
VGA Termination	10	Toggle	=01 Terminate, =00 UnTerminate
Output Resolution	11	Multiple	=01 D-ILA, =02 Triple, =03 Quadrupled, =04 XGA =05 SVGA, =06 Doubled, =07 VGA
Output Sync Select	12	Multiple	=01 5Wire =02 4Wire =03 3Wire
Composite B Input	13	Toggle	=01 Pass Thru, =00 Input
S-VHS B Input	14	Toggle	=01 Pass Thru, =00 Input
YUV B Input	15	Toggle	=01 Pass Thru, =00 Input
Input Aspect	16	Multiple	=01 4:3 =02 4:3LBox =03 16:9
YUV BETA/SMPTE	17	Toggle	=01 Beta =00 SMPTE
Full Reset	18		=01 Full Reset
Mode Reset	19		=01 Mode Rest
Save Settings	20		=01 Save Settings
Keyboard Locked	21	Toggle	=01 Locked =00 Unlocked
Output H and V Size	22	Range	=01 increment H, =02 decrement H, =03 increment V, =04 decrement V
Motion Processing	23	Multiple	=01 Still, =02 Motion, =03 Film, =04 Auto
Saturation	24	Range	=00 to 255
IR Remote Enable	25	Toggle	=01 Enabled =00 Disabled
Output Aspect	26	Multiple	=01 4:3 Top =02 4:3 Middle =03 4:3 Bottom =04 16:9 Top =05 16:9 Middle =06 16:9 Bottom

For example, the following byte sequences perform the indicated functions:

Input Set to Channel A S-VHS

7	5	13
Input Source register	5, therefore S-VHS A	<CR>

Zoom Turned On

16 (decimal)	1	13
Zoom register	1, therefore On	<CR>

Decrement Brightness

4	0	13
Brightness register	Decrement by 1	<CR>

Delay time between each transmitted character of a command must be 10 mS or greater. Each command will not be completed until the Carriage Return is received. If incorrect register numbers are given at the start of any command, the QuadScan will ignore that byte.

Special caution should be used when using the Save Settings Command (Register 20). Excessive repeated use of this command (i. e. inside an endless loop) will damage the QuadScan's Non-Volatile memory.

3) The De-Activation Command is given. When a QuadScan is used in an RS-422 system with several other, QuadScans it will be necessary to De-Activate the currently selected QuadScan to issue commands to another QuadScan in the system. If you are using a single QuadScan, it will not be necessary to De-Activate the QuadScan.

The De-Activation Command consists of the character string: RQOFFx (where x is the address of the QuadScan). The De-Activation Command (and all other commands) must be followed by a Carriage Return (ASCII character value of 13 decimal) to be accepted.

The following byte string (using decimal values for ASCII characters) indicates a valid De-Activation Command for a QuadScan previously programmed to be address 3:

82	81	79	70	70	03	13
R	Q	O	F	F	3	<CR>

If the QuadScan receives any unexpected input before the reception of the De-Activation Command, it will ignore it. If it receives an unexpected byte during the transmission of the De-Activation Command, the De-Activation Command must be re-transmitted (the De-Activation sequence is reset).

5 Appendix A - Limited Warranty

FOCUS Enhancements, Inc. warrants this product against defects in materials and workmanship for a period of THREE (3) YEARS from the date of original purchase.

If you discover a defect, FOCUS Enhancements, Inc. will, at its sole option, repair or exchange the product at no charge to you, provided you contact FOCUS Enhancements, Inc. Technical Support to obtain a Return Material Authorization (RMA) Number and instructions on where and how to obtain repair. Note that a copy of the bill of sale bearing the FOCUS Enhancements, Inc. serial numbers as proof of date of original purchase is required for each product returned for warranty service. Before returning product, remove all non-FOCUS Enhancements, Inc. RAM, accessories, and options. FOCUS Enhancements, Inc. cannot be liable for the return or care of any non-FOCUS Enhancements, Inc. products, nor accept responsibility for loss or damage of product in transit.

This warranty does not apply if the product has been damaged by accident, installation or removal of product, abuse, misuse, misapplication, accident, neglect, fire, water, lightening, or other acts of nature, failure to follow supplied instructions; has been modified, repaired or undergone attempted repair by unauthorized personnel without the written consent of FOCUS Enhancements, Inc.; has a serial number that has been removed, modified, or defaced. FOCUS Enhancements, Inc. reserves the right to use re-manufactured, refurbished, or used parts and components in making warranty repairs.

FOCUS Enhancements, Inc. products are designed to work with Windows™ and MacOS™ computers. Certain features of third-party software or hardware designed for the host system may not be available when used with this product. Accordingly, FOCUS Enhancements, Inc. does not warrant or represent that all third-party software or hardware will function error-free when used in conjunction with this FOCUS Enhancements, Inc. product.

THIS WARRANTY IS IN LIEU OF ALL OTHER WARRANTIES, WHETHER ORAL OR WRITTEN, EXPRESS OR IMPLIED. ALL EXPRESS AND IMPLIED WARRANTIES OF MERCHANTABILITY AND FITNESS FOR A PARTICULAR PURPOSE, ARE LIMITED IN DURATION TO THE WARRANTY PERIOD. NO WARRANTIES, EXPRESS OR IMPLIED WILL APPLY AFTER THIS PERIOD. FOCUS ENHANCEMENTS, INC. SHALL NOT BE LIABLE FOR ANY LOST PROFITS, DAMAGE TO OTHER PROPERTY CAUSED BY A DEFECT IN THIS PRODUCT, DAMAGES BASED UPON INCONVENIENCE, LOSS OF USE OF THE PRODUCT, LOSS OF TIME, COMMERCIAL USE, INCIDENTAL AND/OR CONSEQUENTIAL DAMAGES FOR THE BREACH OF ANY EXPRESS OR IMPLIED WARRANTY, INCLUDING DAMAGE TO PROPERTY AND, TO THE EXTENT PERMITTED BY LAW, DAMAGES FOR PERSONAL INJURY, EVEN IF FOCUS ENHANCEMENTS, INC. HAS BEEN ADVISED OF THE POSSIBILITY OF SUCH DAMAGES.

Some states do not allow the inclusion or limitation of incidental or consequential damages or limitations on how long an implied warranty lasts, so the above limitation or exclusion may not apply to you. This warranty gives you specific legal rights, and you may have other rights, which vary, from state to state.